

FERODO[™]

THE FIRST NAME IN BRAKES

Kart Attack

2006-2007



 **FEDERAL
MOGUL**

Another great brand from Federal-Mogul

Introduction:

This catalogue details the Ferodo Kart Attack range of brake pads for Karting applications. It has been designed for use by both Distributors and Racing Teams and contains full application data, product shape illustrations as well as material compound data.

Part Number/Suffixes:

All part numbers in the range section of this catalogue feature a suffix. This identifies the material compound available for that part number as follows:

KA=Organic Racing **KS=Sintered Racing**

Introduzione:

Il catalogo Ferodo Kart Attack è uno strumento di lavoro che permette alla rete di distribuzione Ferodo ed ai Teams di scegliere correttamente la figura della pastiglia e la miscela per ottenere la miglior efficienza dell'impianto frenante utilizzato.

Significato dei suffissi:

Il suffisso nella parte finale del numero di codice viene utilizzato per identificare la miscela:

KA=Organic Racing **KS=Sintered Racing**

Introduction:

Ce catalogue détaille la gamme des plaquettes de frein Ferodo Kart Attack pour applications karting. Conçu pour une utilisation aisée à la fois des Distributeurs et des Equipes de Course, ce catalogue contient une partie applications et une partie illustrations.

Références/Suffixes:

Tous les codes, dans la section gamme de ce catalogue, contiennent un suffixe. Ce suffixe indique la qualité disponible pour chacune des références. Les matériaux disponibles avec les suffixes appropriés sont les suivants:

KA=Organic Racing **KS=Sintered Racing**

Einführung:

In diesem katalog ist das komplette Ferodo Bremsbelag-Programm für Kart Anwendungen aufgeführt. Der Katalog wurde für Händler und Renn-Teams konzipiert und enthält sämtliche Anwendungsdaten, Produktabbildungen und Materialdaten.

Teile-Nummern/Suffix:

Alle Teile-Nummern in diesem katalog enthalten einen Zusatz. Durch diesen läßt sich das für diese Teile-Nr. verfügbare Material wie folgt identifizieren:

KA=Organic Racing **KS=Sintered Racing**

Introducción:

Este catálogo detalla la gama de pastillas de freno Ferodo Kart Attack, para aplicaciones en Kart. Diseñado para facilitar su uso a Distribuidores y Equipos de Competición, el Catálogo contiene los datos de aplicación/compuesto y la ilustración de las siluetas de las pastillas.

Referencia/Sufijos:

Todas las referencias en la parte gama de ésta catálogo, presentan un sufijo. Este sufijo identifica el material o compuesto disponible para cada referencia en concreto. Los compuestos disponibles y los sufijos respectivos, son los siguientes:

KA=Organic Racing **KS=Sintered Racing**

Ferodo kart pad reference

Adaptable to:

FDB207 KS	Alpha (rear) Brembo calipers Sodikart (rear)
FRP213 KA	Kelgate
FDB342 KA	Anderson Big Bowman English Kart Kelgate Solo (rear) Stratos
FRP405 KS	Brembo calipers Track Magic (front)
FDB2021 KA	Ey Racing Heka Kart Kart components Project 1 (rear) Lockheed calipers
FDB2038 KA	Alpha MBA Righetti Ridolfi Top Kart (rear) Wilson Zip Kart
FDB2046 KA	Biesse (rear) Birel Europa GoKart Haase Sodikart
FDB2047 KA	Birel (front)
FDB2051 KA	Swiss Hutless (rear)
FDB2064 KA	Como (rear) English Kart
FDB2069 KA	Birel (rear)
FDB2070 KA	Arc Piranha (rear) Righetti Ridolfi Venom
FDB2071 KA	CRG (front)
FDB2072 KA	CRG (rear)
FDB2074 KS	Brembo calipers
FDB2076 KA	Haase (front)
FDB2077 KA	Tony Kart Trulli (front)
FDB2078 KA	Tony Kart Trulli (rear)
FDB2081 KS	Brembo calipers Grimeca calipers Track magic (rear)
FDB2082 KA	All Kart
FDB2088 KA	CRG Kombi Kart PCR Techno Kart
FDB2089 KA	Alpha (rear) Mach 1 Techno (rear)
FDB2092 KA	CRG (rear)
FDB2093 KA	CRG (rear) Top Kart (front) Wilson (front)
FDB2104 KA	Birel (rear)
FDB2112 KA	Alpha MBA Top Kart Wilson
FDB2116 KA	Mach 1
FDB2118 KA	Birel (front)
FDB2151 KS	CRG 2000 (front and rear)
FDB2152 KA	CRG 1999 (front)

Kart Attack 06-07



FDB 2051

W 93.7mm x H 36.7mm x D 13.6mm

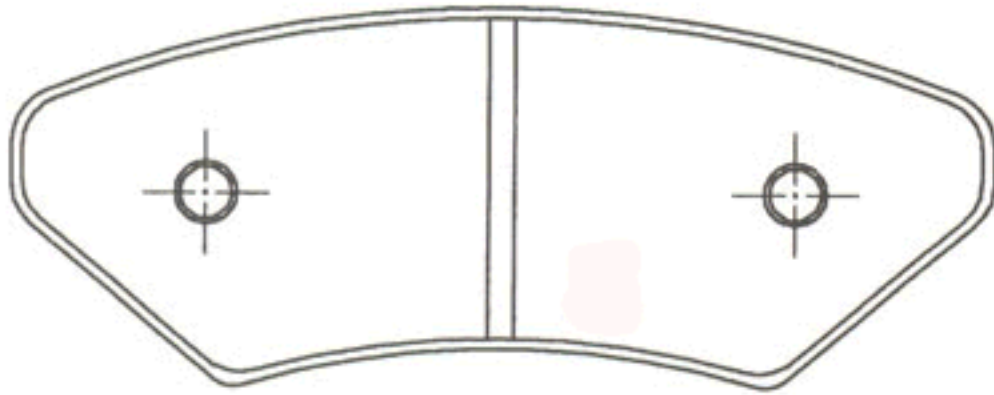

FDB 2064

W 98.8mm x H 38.8mm x D 17mm

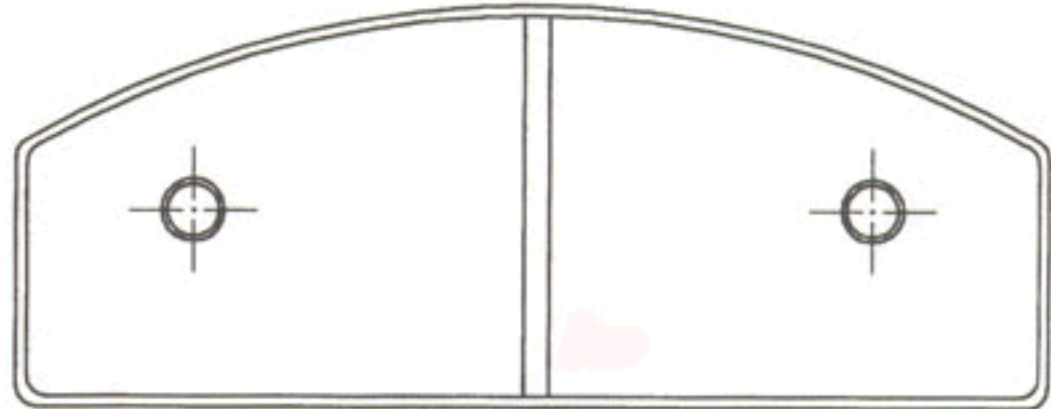

FDB 2071

W 84.4mm x H 51.5mm x D 10.2mm

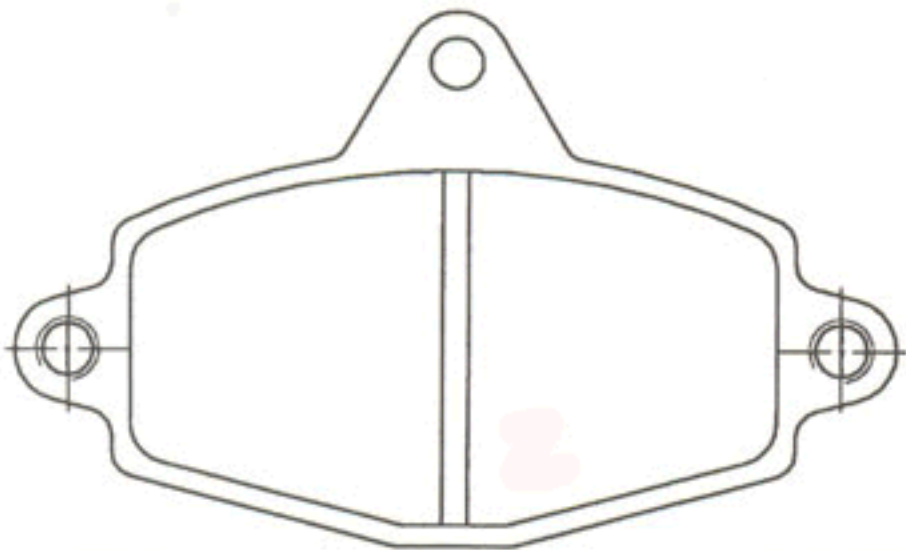

FDB 2072

W 84.4mm x H 51.5mm x D 15mm

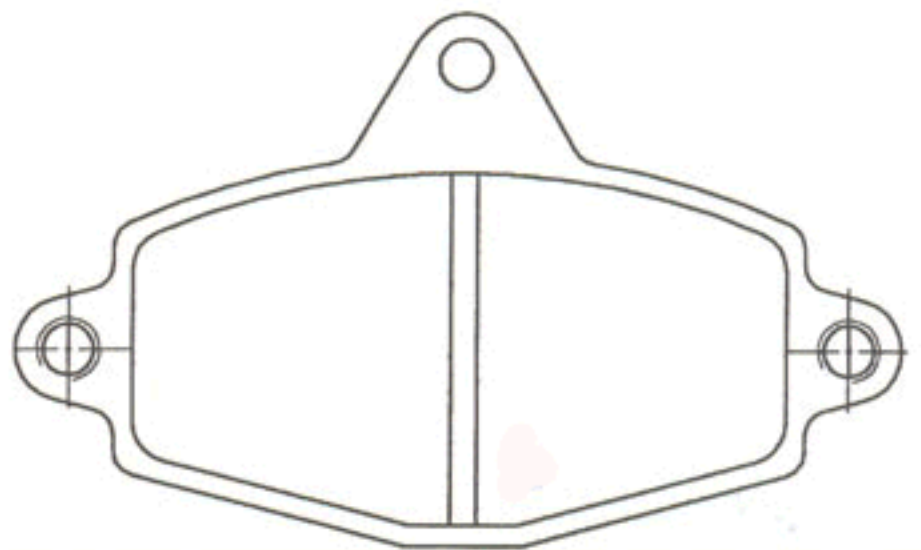

FDB 2077

W 57.1mm x H 44.5mm x D 10mm

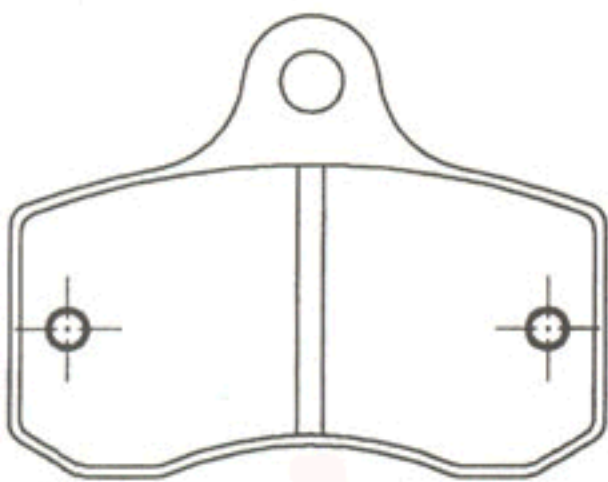

FDB 2078

W 71.4mm x H 53.9mm x D 16mm

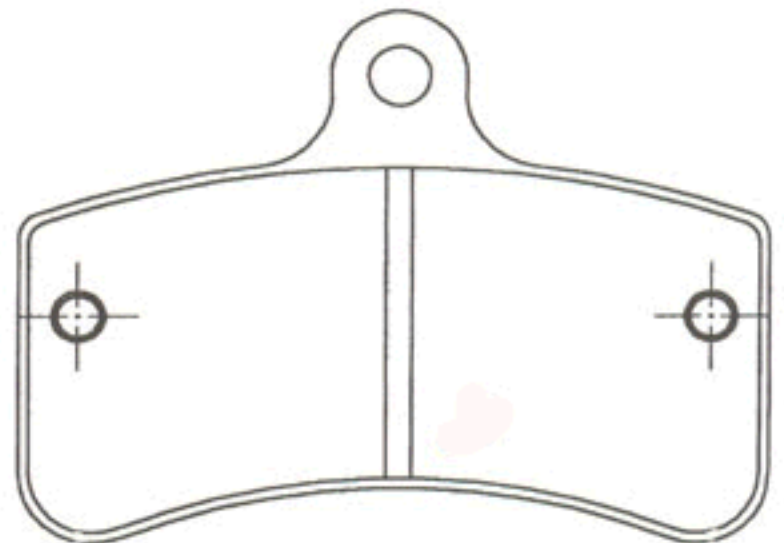

FDB 2088

W 98.8mm x H 38.8mm x D 17mm

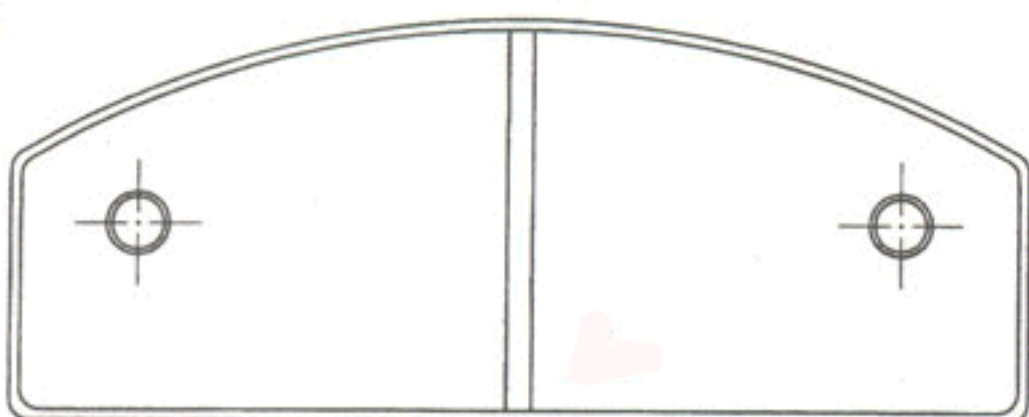

FDB 2089

W 98.8mm x H 38.8mm x D 17.3mm

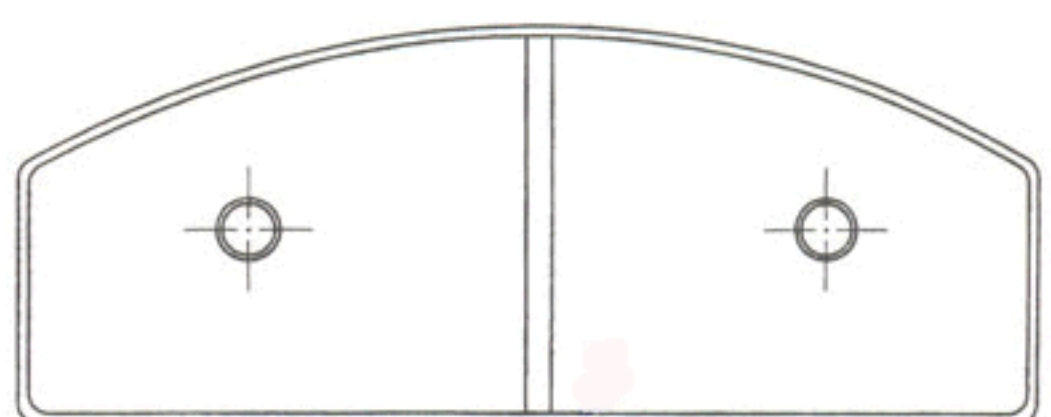

Kart Attack 06-07

FDB 2069

W 90.2mm x H 55.1mm x D 11.5mm

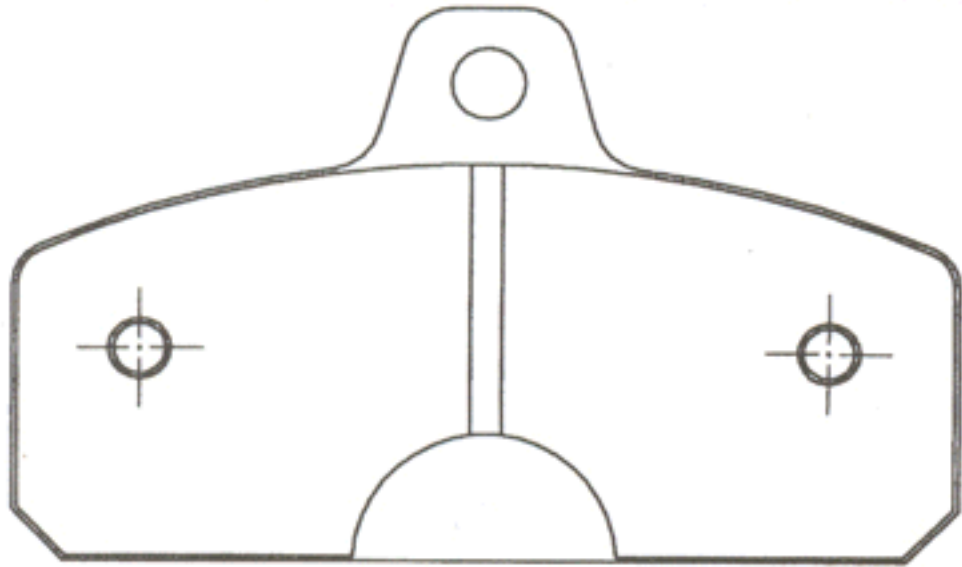

FDB 2070

W 90.2mm x H 55.1mm x D 13mm

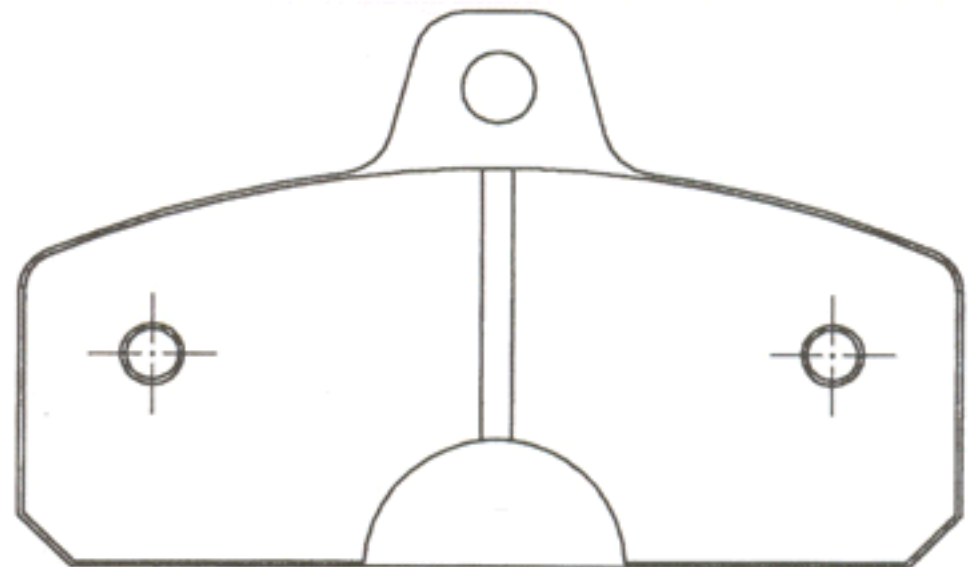

FDB 2074

W 51mm x H 54mm x D 7.5mm



FDB 2076

W 67.4mm x H 26.6mm x D 6.8mm

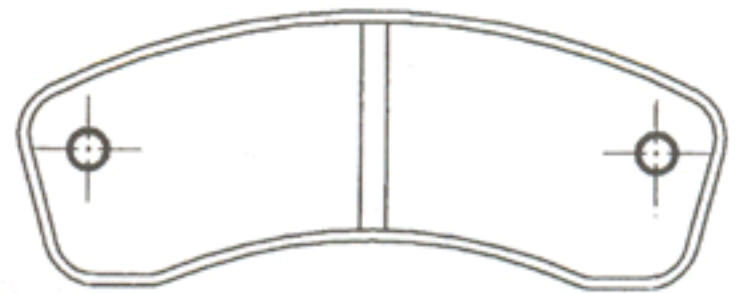

FDB 2081

W 39.8mm x H 56.6mm x D 8mm



FDB 2082

W 91mm x H 38.8mm x D 13mm

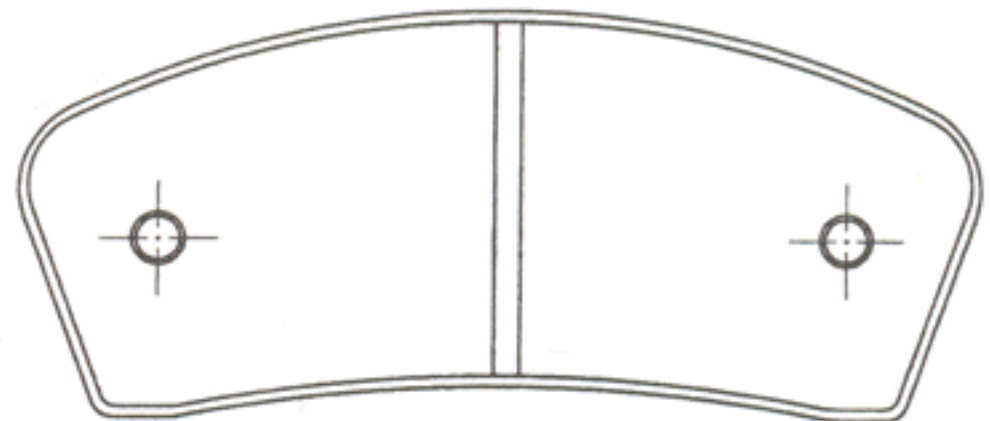

FDB 2092

W 108.1mm x H 48.3mm x D 13.7mm

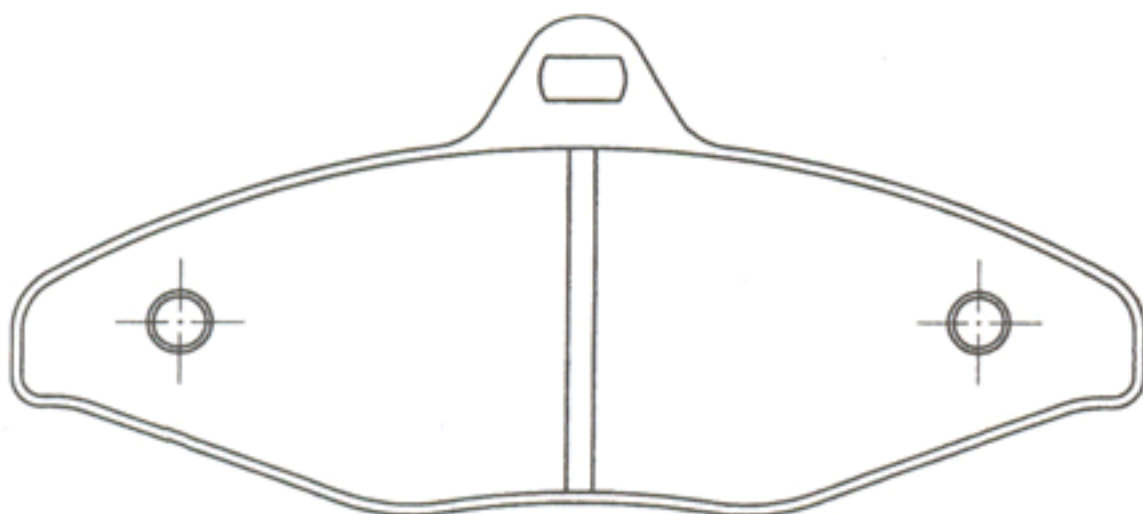

FDB 2093

W 84.4mm x H 50.6mm x D 10mm

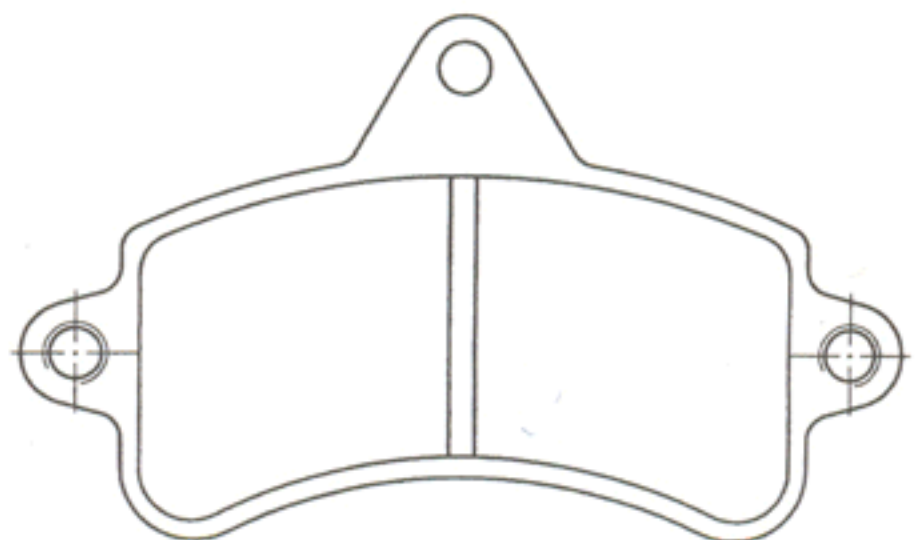

Kart Attack 06-07



FDB 207

W 40mm x H 56.4mm x D 7mm



FRP 213

W 59.5mm x H 54.4mm x D 10.2mm

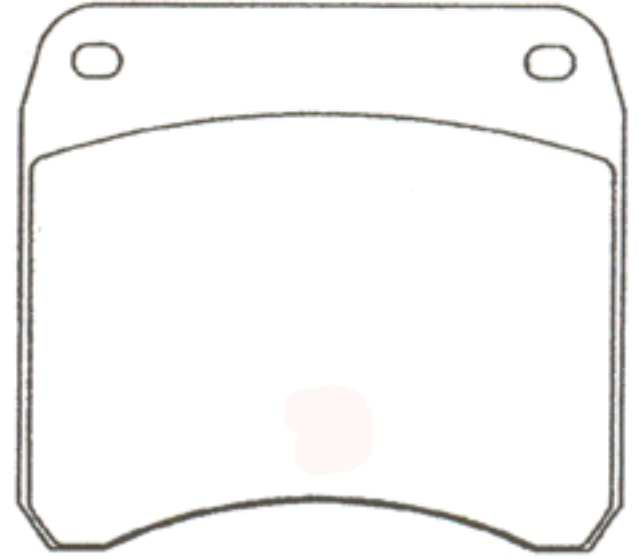

FDB 342

W 59.5mm x H 51.6mm x D 10.2mm

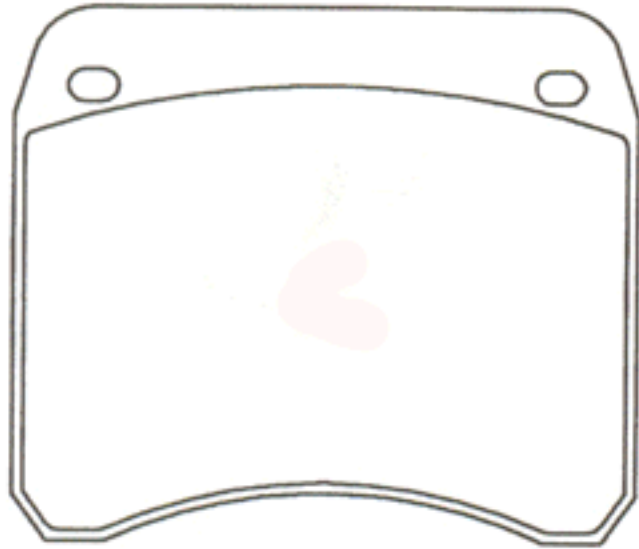

FRP 405

W 36.1mm x H 45.1mm x D 6mm



FDB 2021

W 97.1mm x H 40.1mm x D 14.5mm

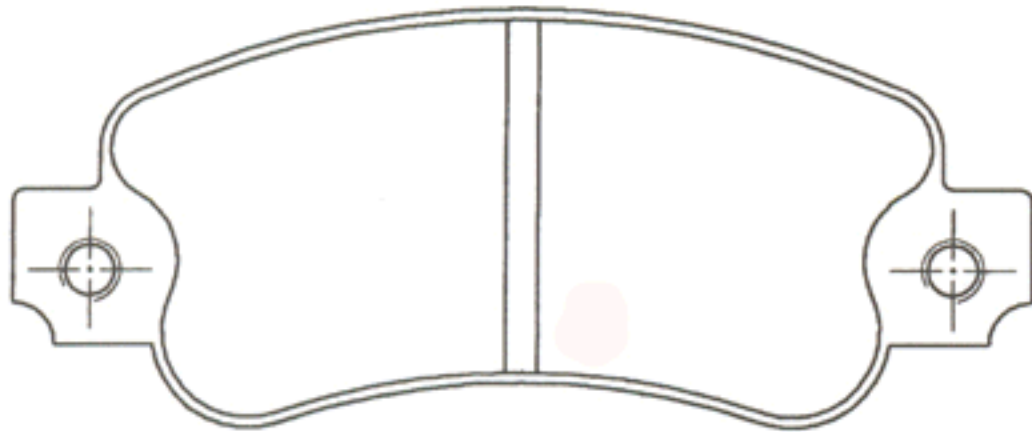

FDB 2038

W 98.8mm x H 38.8mm x D 13.6mm

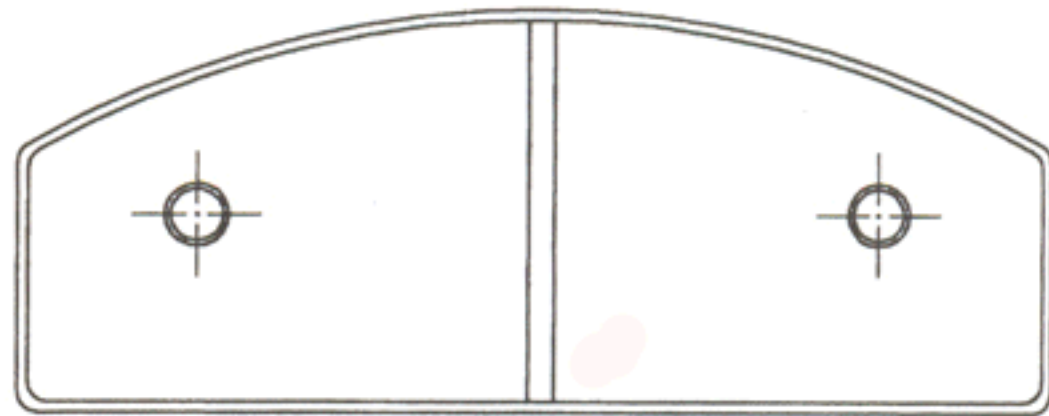

FDB 2046

W 90.2mm x H 55.1mm x D 16mm

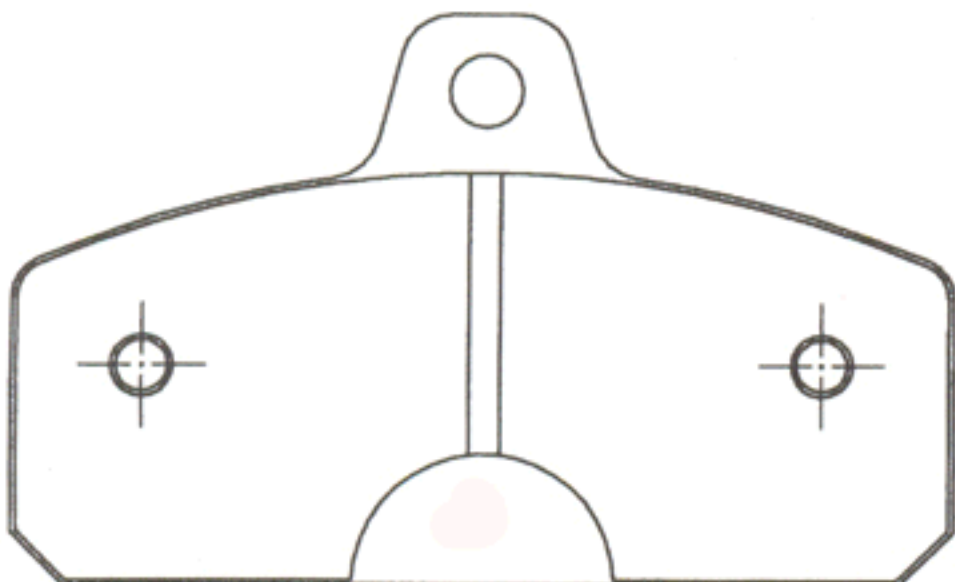

FDB 2047

W 75.2mm x H 52.1mm x D 10mm

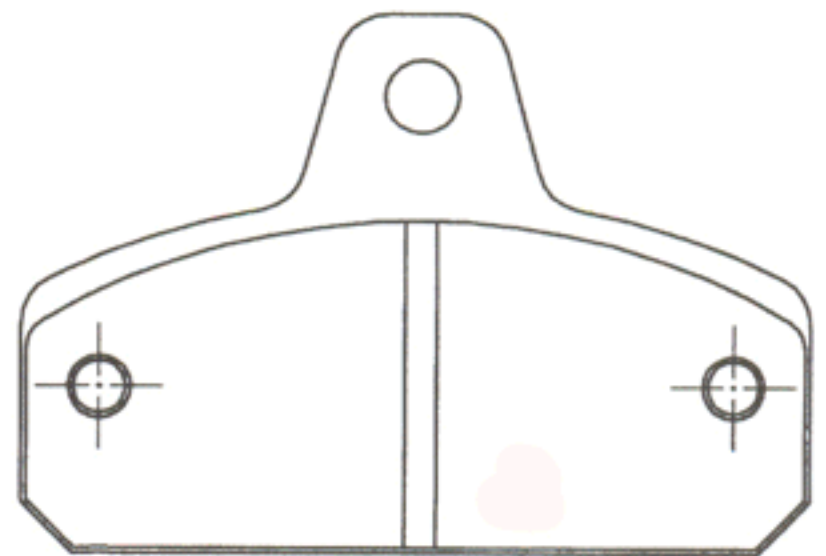

KS = Sintered Racing

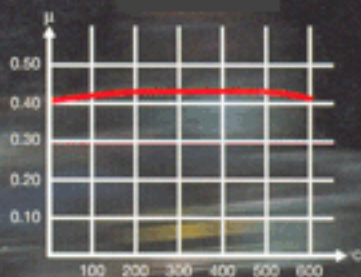

Federal-Mogul Aftermarket Italia Srl
 Corso Inghilterra, 2 I-12084 MONDOVI (CN) Italy
 T: 00.39.0174.560511 F: 00.39.0174.552248

KA = ID 460

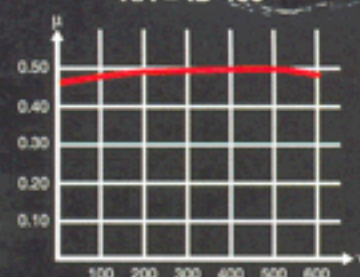

Compounds, Mescole, Matériaux, Materialien, Compuestos;

SINTERED & ORGANIC ID460

GB - ID 460 The material for professional drivers. Very high and stable coefficient of friction (0,48). This material is not sensitive to speed and/or temperature. High initial bite and very predictable when braking into the turn (great feel!).

I - ID 460 È la mescola dei piloti professionisti. Ha un coefficiente d'attrito molto alto e stabile (non sensibile a velocità e/o temperatura): 0,48. Fantastico attacco iniziale e facilmente gestibile quando si porta il kart al punto di corda (prevedibile quando si frena in curva).

F - ID 460 La qualité pour pilotes professionnels. Coefficient de friction très élevé et stable en toute circonstance (0,48). Pas de sensibilité à la vitesse et/ou à la température. Mordant initial élevé et sûr

quelle que soit l'intensité du freinage.

D - ID 460 Das Material für den professionellen Kart-Rennfahrer. Sehr hoher und konstanter Reibwertkoeffizient (0,48). Extrem hohe thermische Belastbarkeit und Geschwindigkeitsunempfindlichkeit. Sofortiges Ansprechen und sehr gutes Bremsgefühl (gute Dosiereigenschaften).

E - ID 460 El compuesto para pilotos profesionales. Coeficiente de Fricción muy alto y estable en cualquier condición (0,48). Sin sensibilidad a la velocidad y/o temperature. Retención inicial fuerte y predecible control de frenada dentro de la curva (Buen tacto).

FDB 2104

W 135.1mm x H 53.1mm x D 15mm

FRP 2116

W 57mm x H 44.5mm x D 8mm

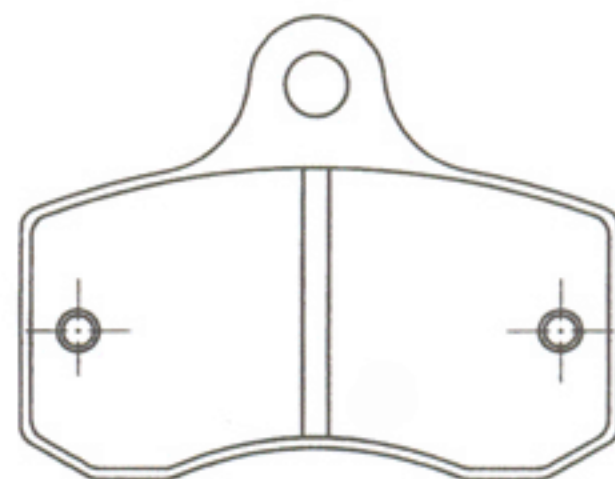
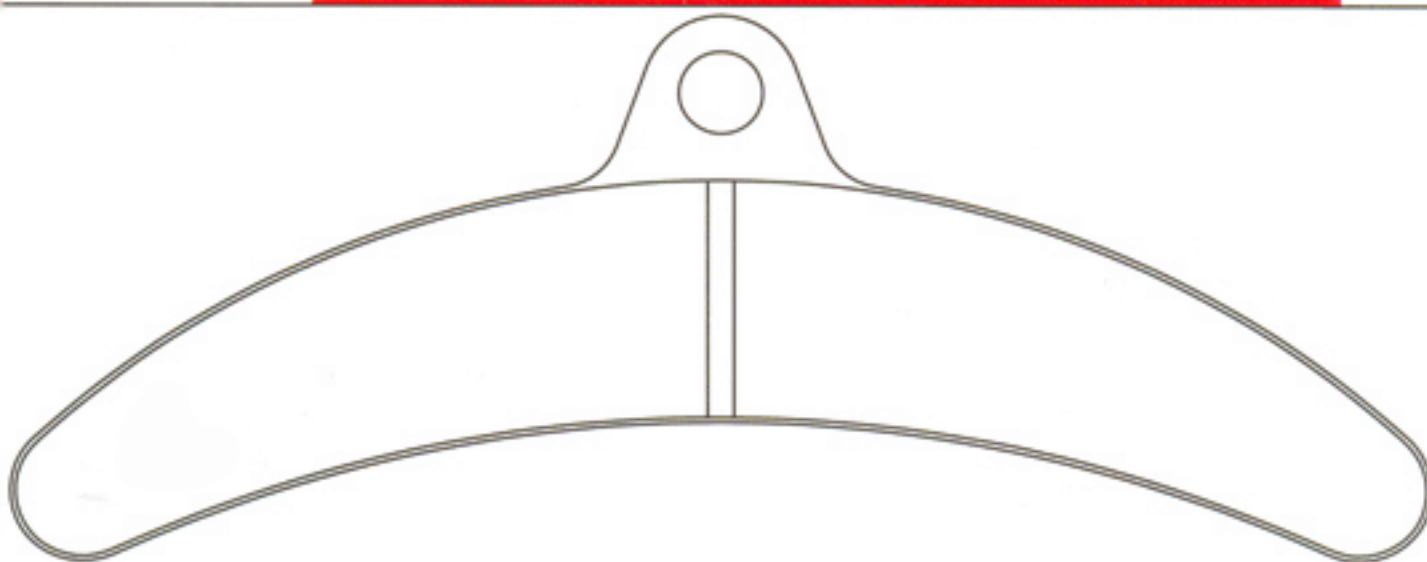

FDB 2112

W 99.1mm x H 39mm x D 12mm

FDB 2118

W 100mm x H 40.4mm x D 11mm

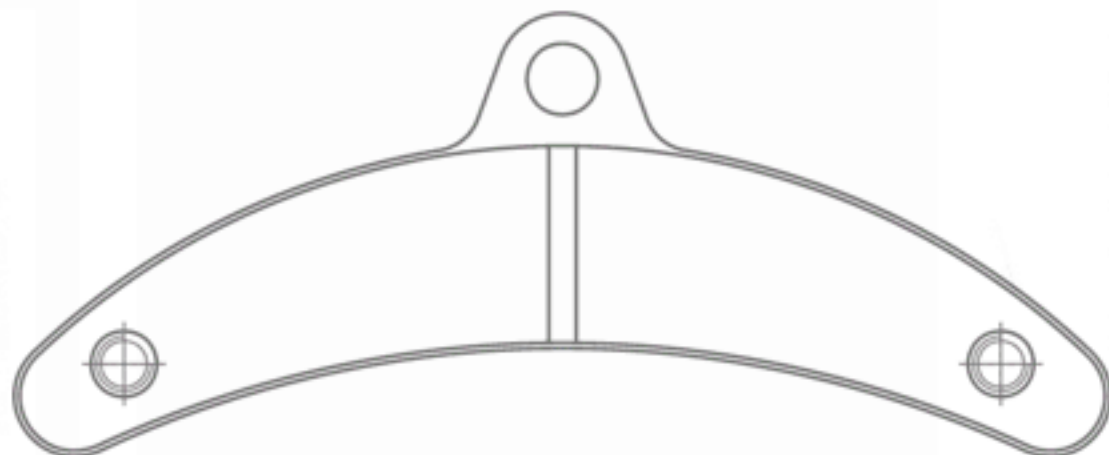
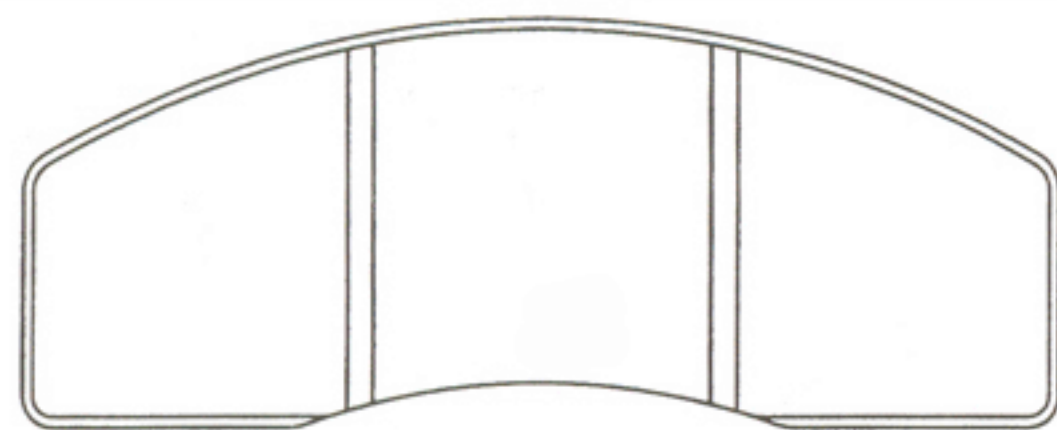

FDB 2151

W 38mm x
H 49.1mm x D 8.5mm

FDB 2152

W 82.2mm x
H 46.9mm x D 10mm

